

Technical Specification

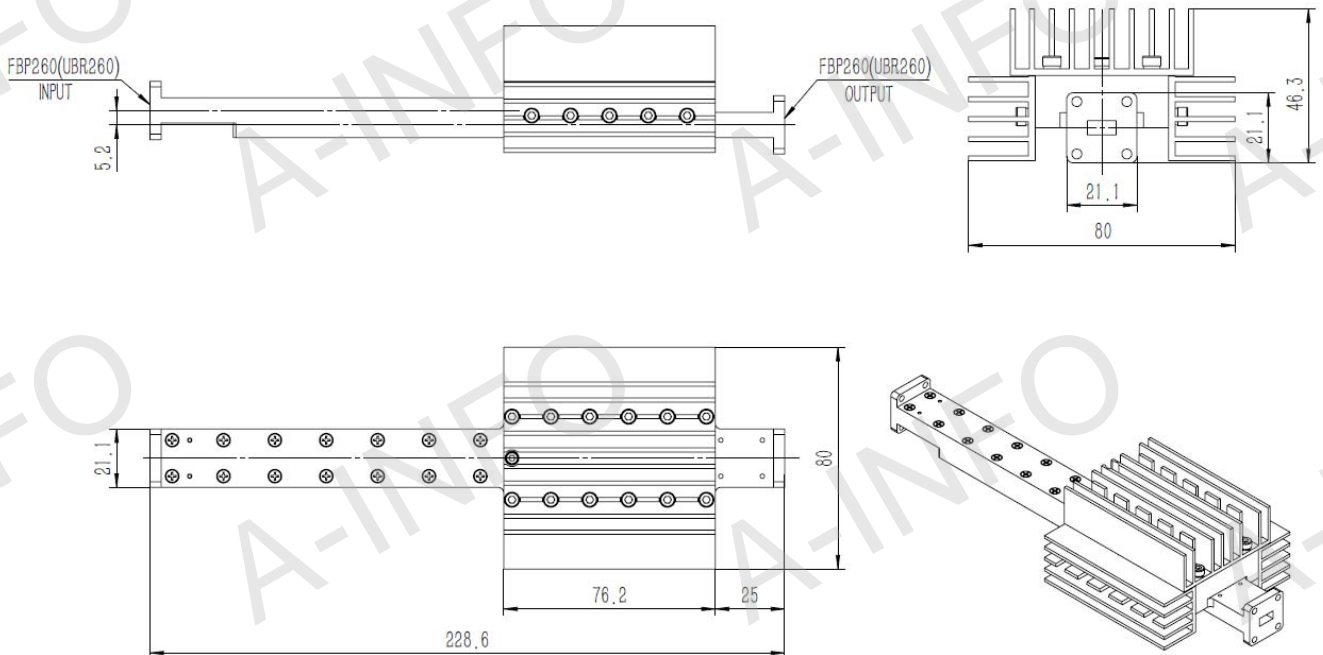

EIA WR	WR34
Frequency Range(GHz)	22.0-33.0
Attenuation(dB)	20
Attenuation Accuracy(dB)	±1.0 Max.
Attenuation Sensitivity(dB)	±0.9 Max.
VSWR	1.2:1 Max.
Average Power(W)	150 CW
Peak Power(KW)	80
Flange	FBP260(UBR260)
Material	Al
Size(mm)	228.6 x 80 x 46.3
Net Weight(Kg)	0.35 Around

Outline Drawing (Size: mm)



Flange Drawing (Size: mm)

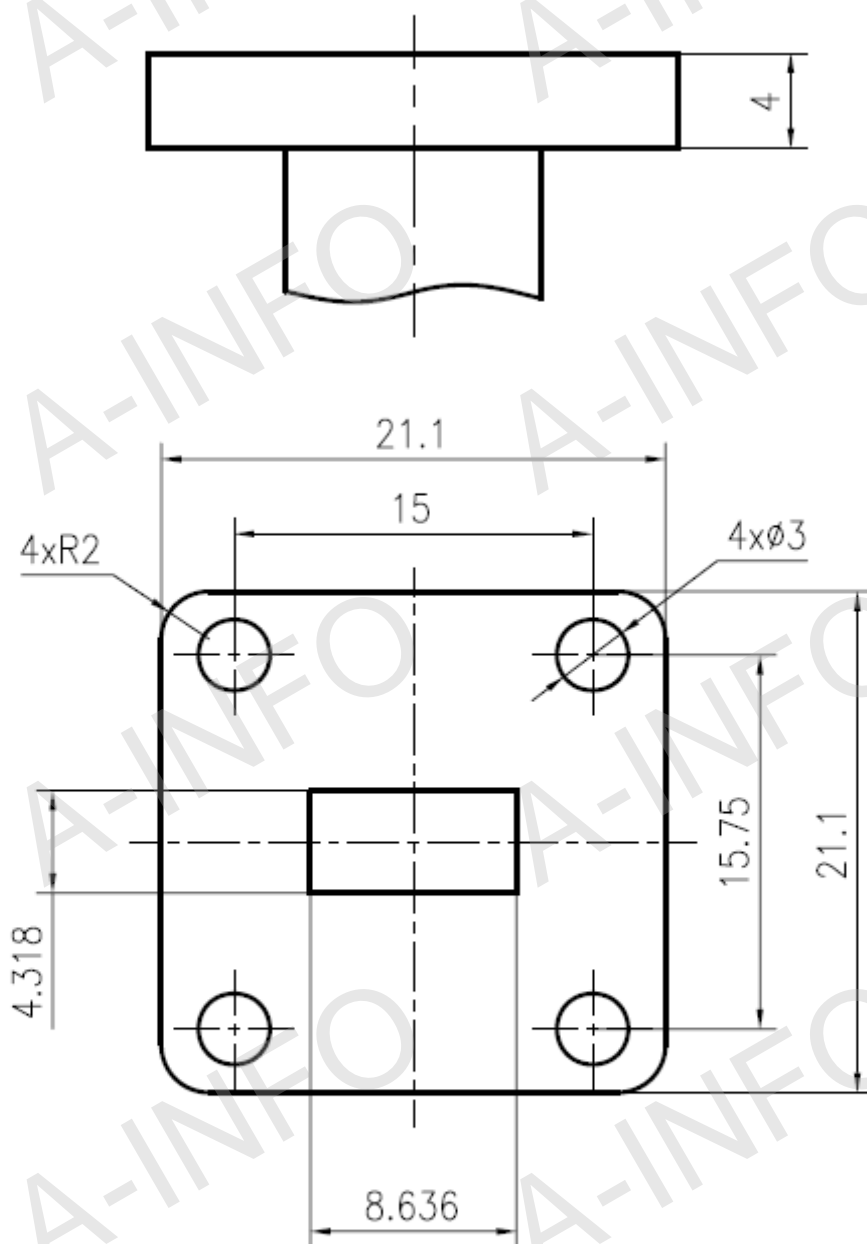

FBP260

AINFO Inc.

Page 2 of 3

China(Beijing):
China(Chengdu):
USA :

Tel: (+86) 10-6266-7326,
Tel: (+86) 28-8519-2786,
Tel: (+1) 949-639-9688,

(+86) 10-6266-7327
(+86) 28-8519-3044
(+1) 949-639-9608

Fax: (+86) 10-6266-7379
Fax: (+86) 28-8519-3068
Fax: (+1) 949-639-9670

Website: www.ainfoinc.com
Email: sales@ainfoinc.com

Test Results

Attenuation & VSWR

