

Technical Specification

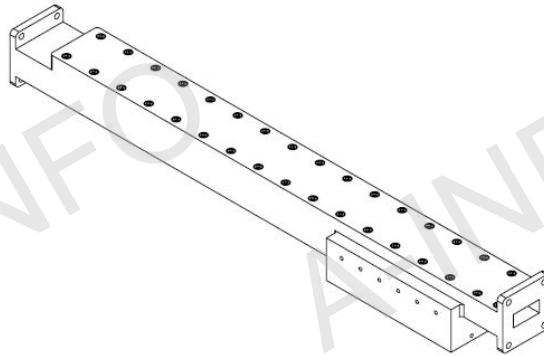

EIA WR	WR90
Frequency Range(GHz)	8.2-12.4
Attenuation(dB)	50
Attenuation Accuracy(dB)	±0.9 Max.
Attenuation Sensitivity(dB)	±0.7 Max.
VSWR	1.15:1 Max.
Average Power(W)	225 CW
Peak Power(KW)	225
Flange	FBP100(UBR100)
Material	Al
Size(mm)	431.8 x 60 x 53
Net Weight(Kg)	1.35 Around

Outline Drawing (Size: mm)

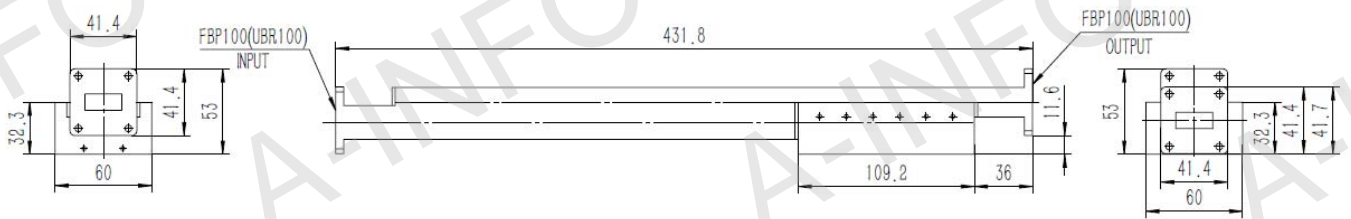

Flange Drawing (Size: mm)

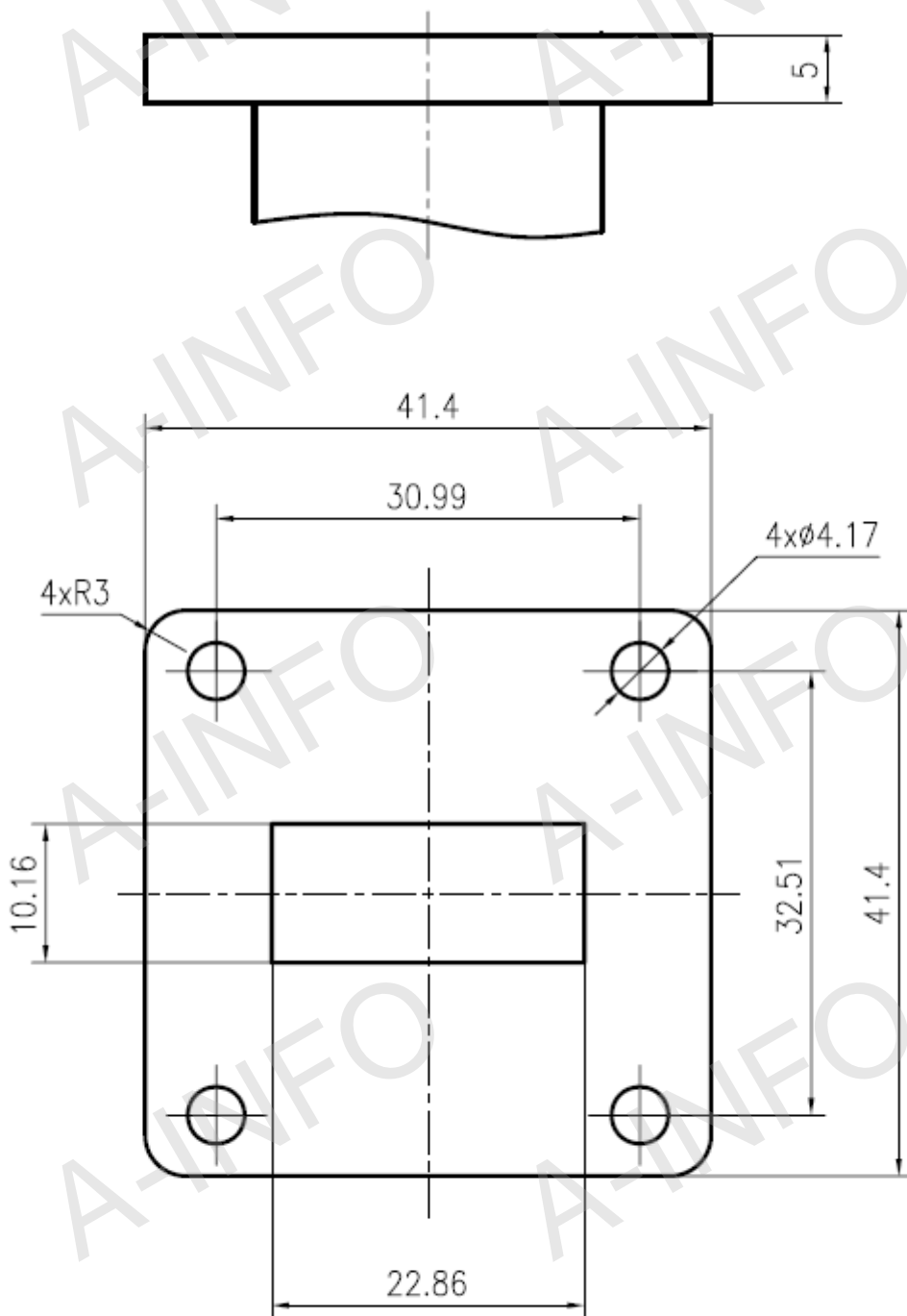

FBP100

AINFO Inc.

Page 2 of 3

China(Beijing):
China(Chengdu):
USA :

Tel: (+86) 10-6266-7326,
Tel: (+86) 28-8519-2786,
Tel: (+1) 949-639-9688,

(+86) 10-6266-7327
(+86) 28-8519-3044
(+1) 949-639-9608

Fax: (+86) 10-6266-7379
Fax: (+86) 28-8519-3068
Fax: (+1) 949-639-9670

Website: www.ainfoinc.com
Email: sales@ainfoinc.com

Test Result

Attenuation & VSWR

