

Technical Specification

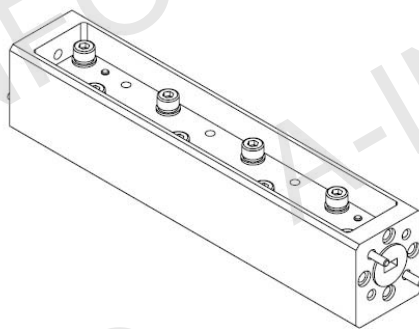

EIA WR	WR15
Frequency Range(GHz)	50.0 - 75.0
Attenuation(dB)	10
Attenuation Accuracy(dB)	±1.3 Max.
Attenuation Sensitivity(dB)	±0.9 Max.
VSWR	1.20:1 Max.
Average Power(W CW)	0.6
Peak Power(KW)	0.1
Flange	FUGP620(UG-385/U)
Material	Cu
Size(mm)	101.6 x 19.1 x 21.0
Net Weight(Kg)	0.16 Around

Outline Drawing (Size: mm)

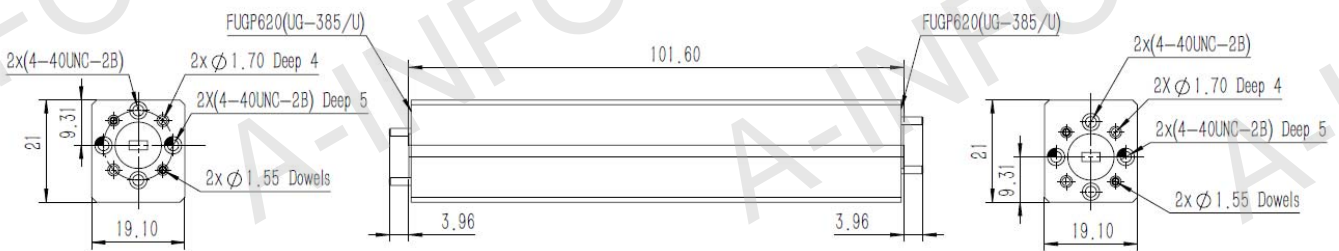

AINFO Inc.

Page 1 of 3

China(Beijing):
China(Chengdu):
USA :

Tel: (+86) 10-6266-7326,
Tel: (+86) 28-8519-2786,
Tel: (+1) 949-639-9688,

(+86) 10-6266-7327
(+86) 28-8519-3044
(+1) 949-639-9608

Fax: (+86) 10-6266-7379
Fax: (+86) 28-8519-3068
Fax: (+1) 949-639-9670

Website: www.ainfoinc.com
Email: sales@ainfoinc.com

Flange Drawing (Size: mm)

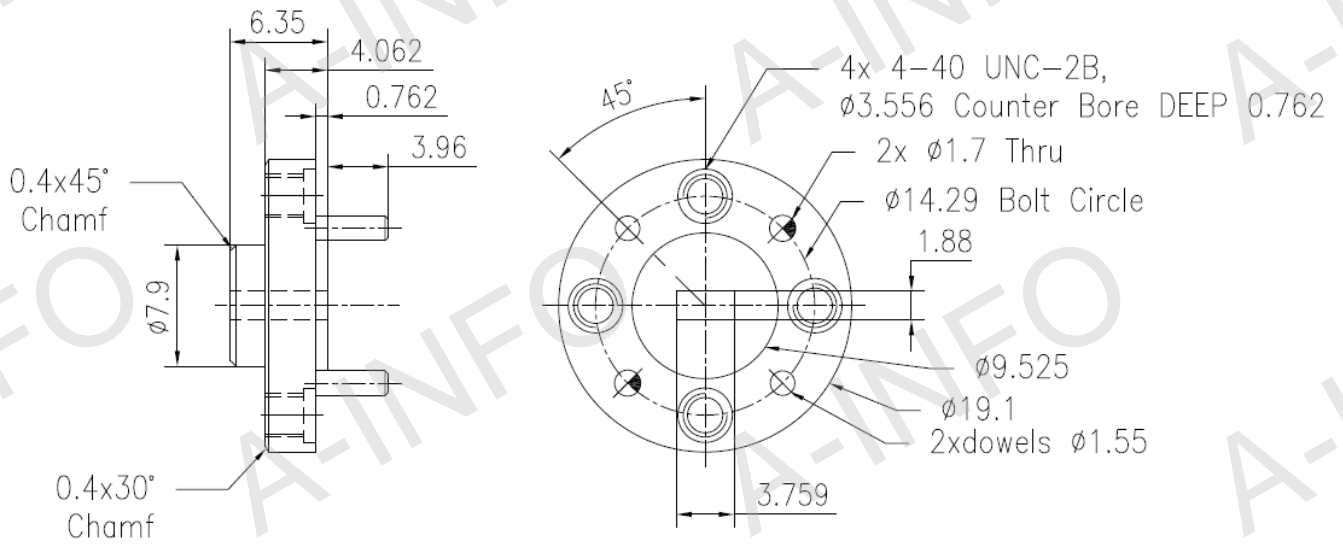

FUGP620
(equivalent to UG-385/U)

Test Results

Attenuation

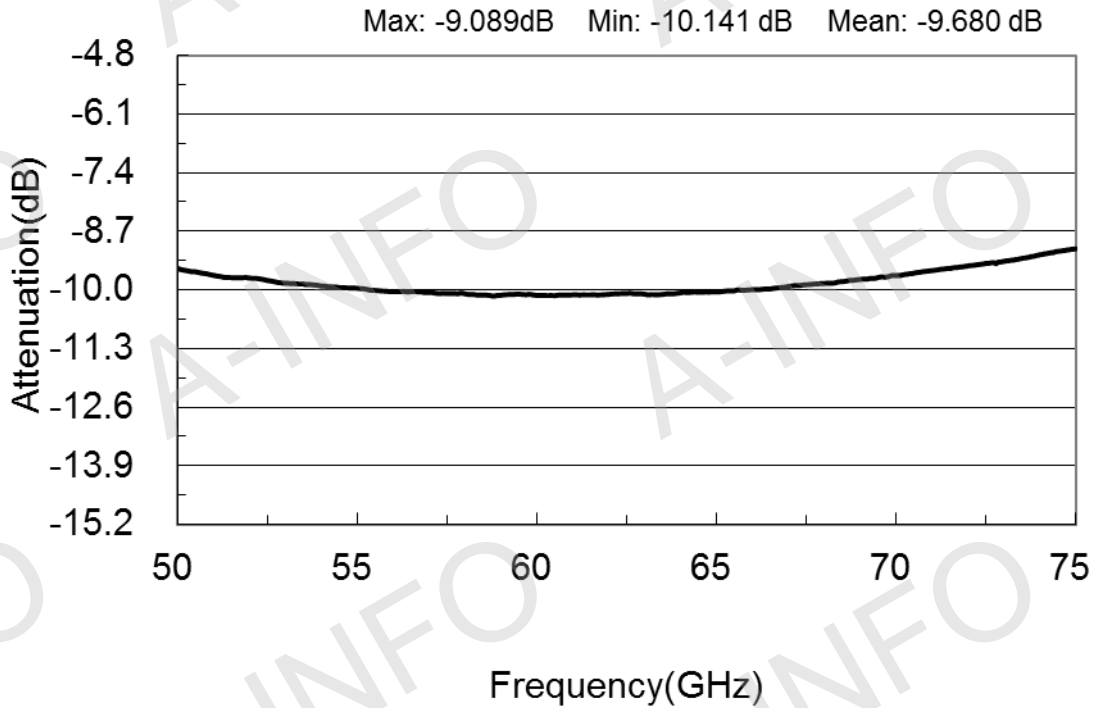

VSWR

