

Technical Specification

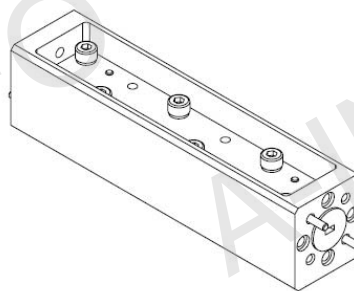

Waveguide	WR10
Frequency Range(GHz)	75.0-110.0
Attenuation(dB)	20
Attenuation Accuracy(dB)	±1.3 Max.
Attenuation Sensitivity(dB)	±0.9 Max.
VSWR	1.15:1 Max.
Average Power(W)	0.4 CW
Peak Power(KW)	0.03
Flange	FUGP900(UG-387/U-M)
Material	Cu
Size(mm)	82.55 x 19.1 x 20.6
Net Weight(Kg)	0.14 Around

Outline Drawing (Size: mm)

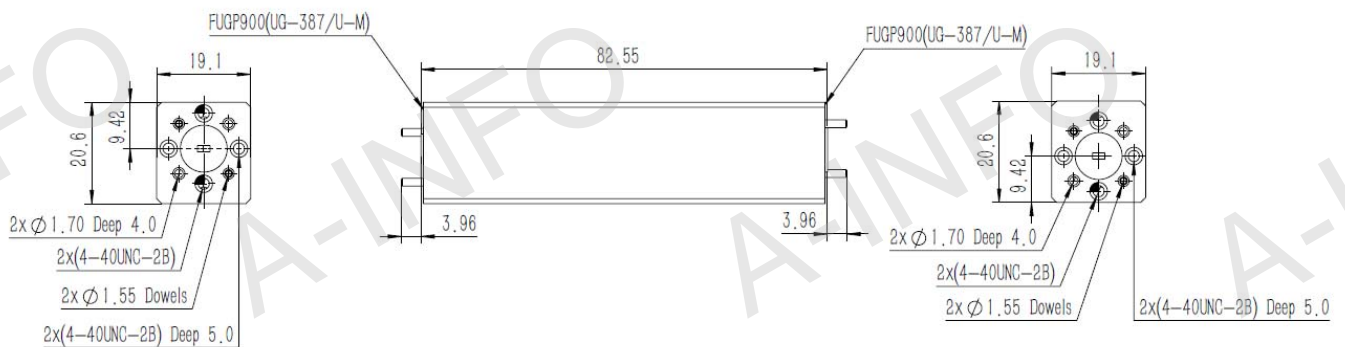

Flange Drawing (Size: mm)

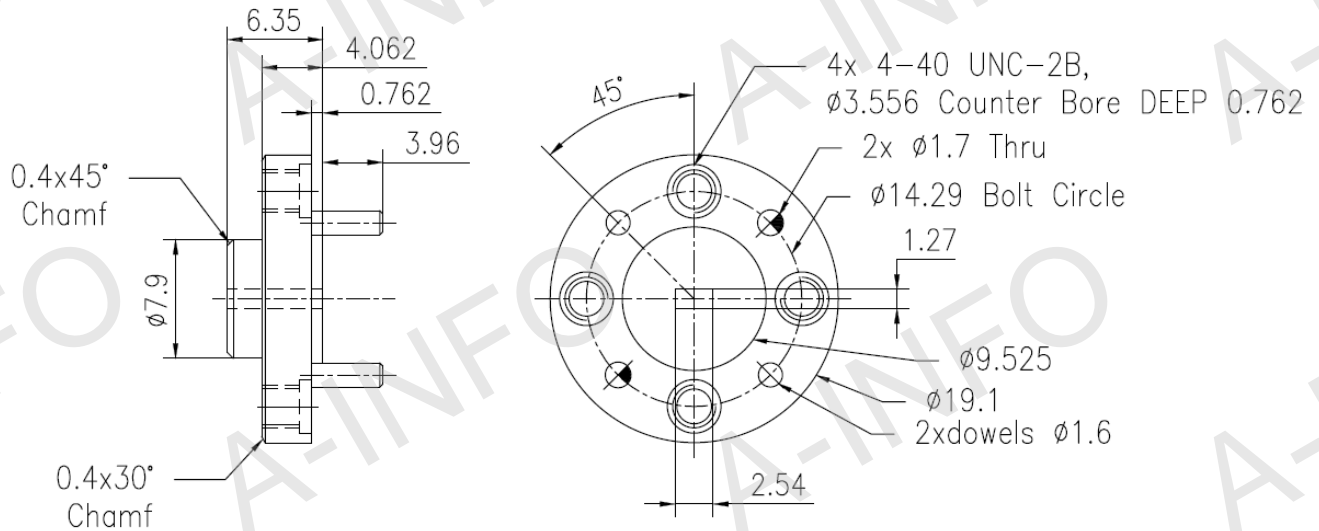

FUGP900
(equivalent to UG-387/U-M)

Test Results

