

Technical Specification

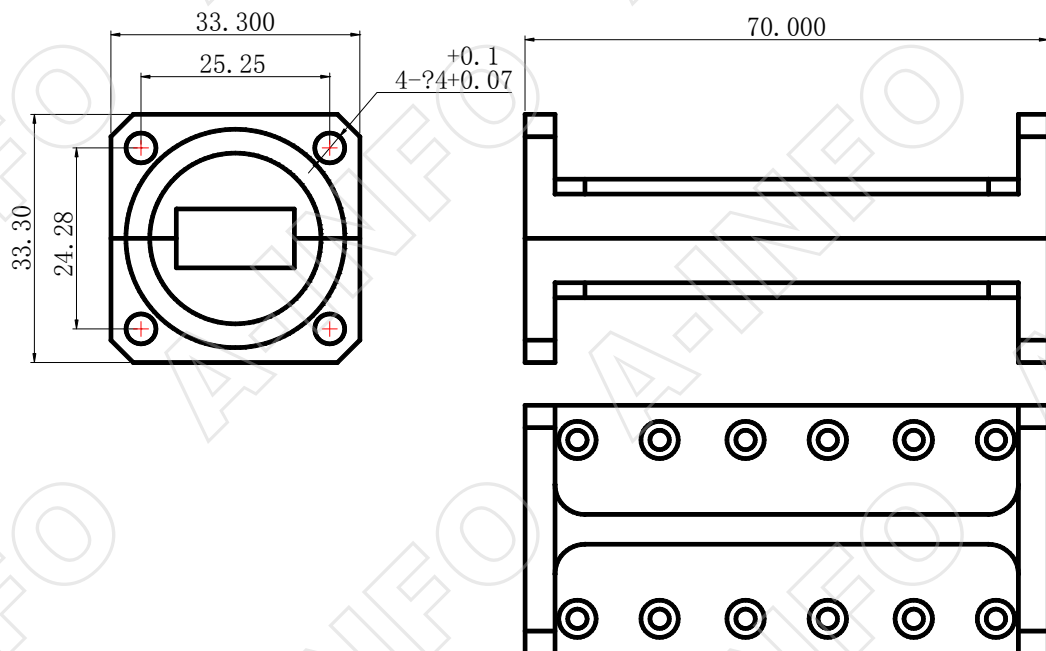

EIA WR	WR62
Frequency Range(GHz)	12.4-18.0
Attenuation(dB)	3
Accuracy(dB)	±1.0 max
VSWR	1.25 max
Flange	FBM140
Power Handling(W)	5
Material	Cu
Net Weight(Kg)	0.20 Around

Outline Drawing (Size: mm)



Test Results

