

Technical Specification

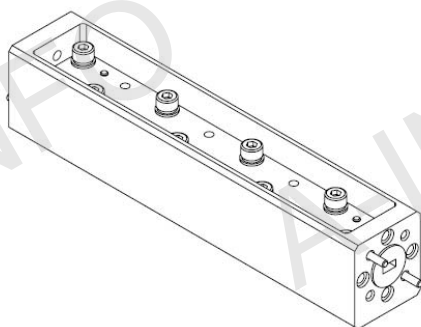

EIA WR	WR15
Frequency Range(GHz)	50.0 - 75.0
Attenuation(dB)	6
Attenuation Accuracy(dB)	±1 Max.
VSWR	1.25:1 Max.
Power Handling(W)	1 CW
Flange	FUGP620(UG-385/U)
Material	Cu
Size(mm)	101.6 x 19.1 x 21
Net Weight(Kg)	0.16 Around

Outline Drawing (Size: mm)

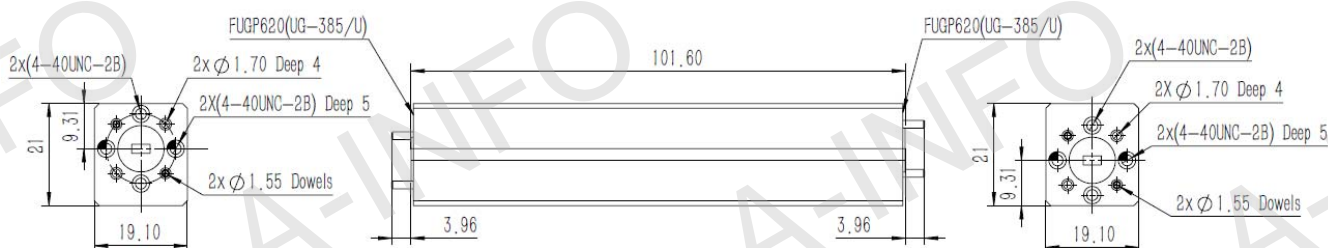

Flange Drawing (Size: mm)

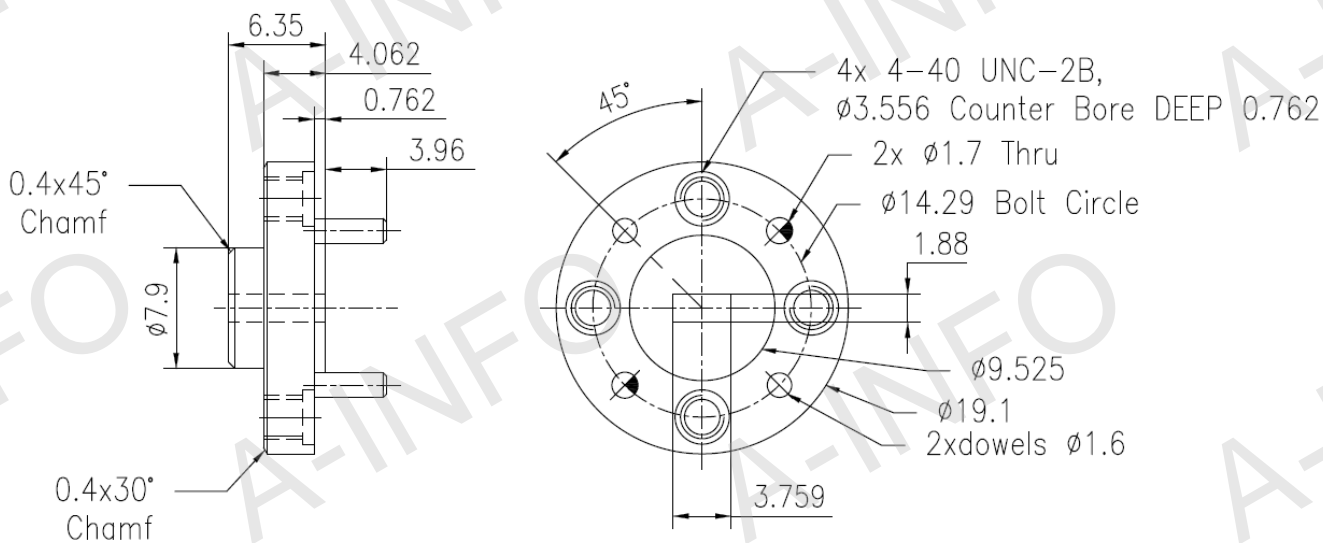

FUGP620
(equivalent to UG-385/U)

Test Result

Attenuation

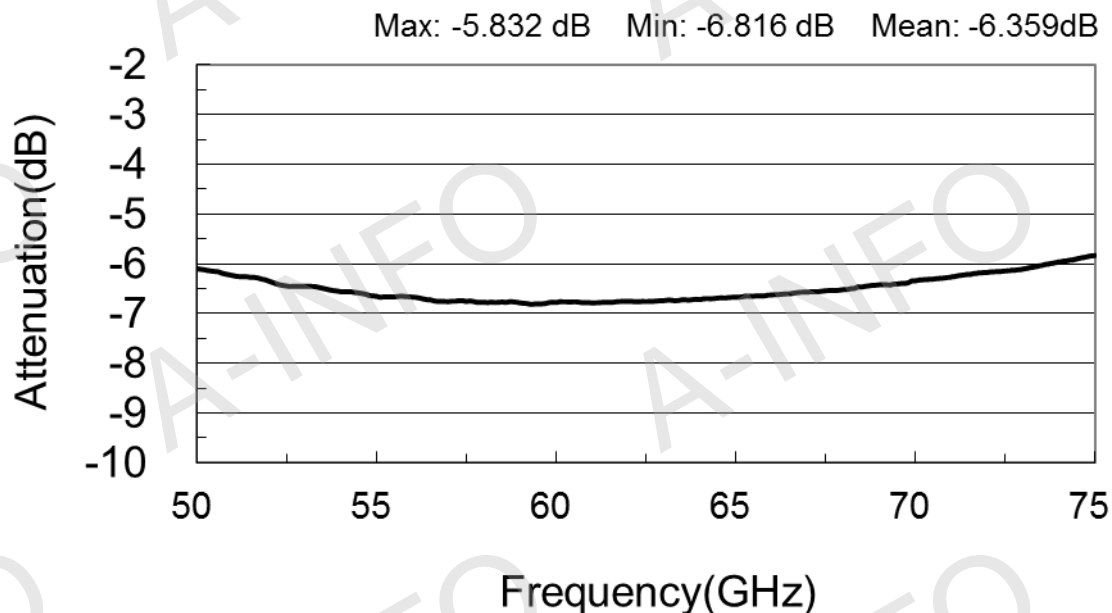

VSWR

