

Technical Specification

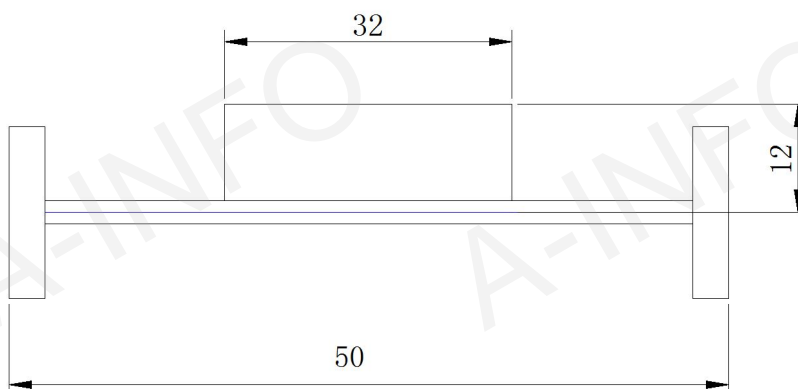

Frequency Range(GHz)	75.0 - 110.0
Waveguide	WR10
Attenuation(dB)	30
Accuracy(dB)	±3 Max.
VSWR	1.25 Max.
Flange	FUGP900 (UG-387/U modified)
Power Handling(W)	0.5
Material	Cu
Net Weight(Kg)	0.5 Around

Outline Drawing (Size: mm)



Flange Outline Drawing (Size: mm)

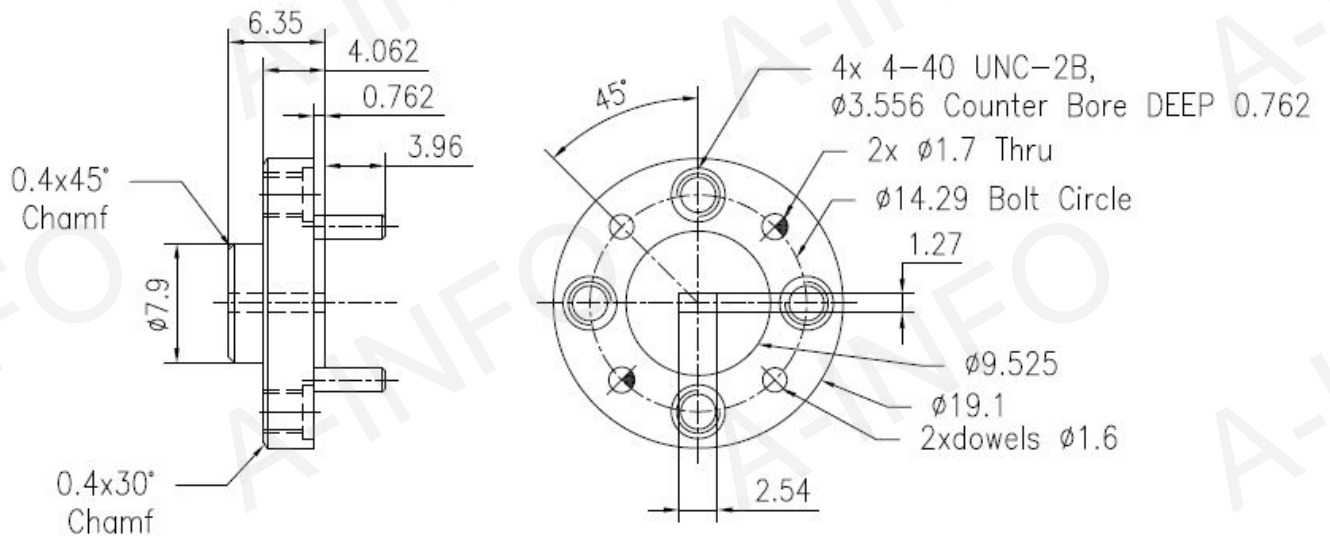

FUGP900
(equivalent to UG-387/U modified)

Test Results

Attenuation



VSWR

